

Mechanized Solutions



Basic Automation Solutions



Integrated Solutions



Robotic Solutions



Digital Submerged Arc Welding Systems

***Advanced Control
Enhanced Deposition
Faster Travel Speeds***

**LINCOLN[®]
ELECTRIC**



About The Lincoln Electric Company

Lincoln Electric is the world's leading manufacturer of welding equipment and consumables. Our focus is helping companies make their welding operations more effective, more efficient, and more profitable.

We are dedicated to two equally important goals:

Exceptional quality and exceptional service

Our field support team — with hundreds of field sales engineers and thousands of knowledgeable and responsive Lincoln Electric distributors in countries all over the world — is the largest in the industry.

Innovative thinking

For a quality, service-first attitude; innovative design, manufacturing, and packaging; and worldwide strength — Choose Lincoln Electric.

Submerged Arc Welding Platforms

Lincoln Electric's advanced submerged arc systems couple the industry's most advanced power source with mobile, hard automation or robotic feeding equipment to achieve new levels of welding performance and operational efficiency.

Whether your application is bridge decking, pressure vessels, panel line, seamer, pipe mill integrator solutions or submerged arc robotic welding, the software-driven Power Wave® AC/DC 1000® SD and your choice of integrated feeding equipment can help your operations improve weld quality, reduce welding and operational costs and increase weld team productivity.

Advanced Control

- Our Waveform Control Technology® allows operators to set all AC and DC arc and PLC-based fixture motion control parameters from a single mountable or hand-held extended-range pendant. It is no longer necessary to reverse electrode and work cables.

Energy Savings

- With input current requirements reduced by up to 50% for our inverter-based system, customers consistently report significant energy savings over traditional submerged arc welding equipment.

Modular Components

- Power Wave® and MAXsa® controller and feed head components are engineered to readily adapt the system for use in almost any indoor or outdoor heavy wall thickness submerged arc welding application.

Rugged Reliability

- Power source, controller and feed heads are reliability tested to meet IP23 standards. Each is designed to withstand harsh environments and outdoor storage.

Lincoln Electric technical teams are standing by to assist you with set up, customized welding mode development optimized for your application, and welding consumables testing and selection.



Power Source

Power Wave® AC/DC 1000® SD 4-5



Mechanized Solution

Power Wave® AC/DC 1000® SD
Cruiser® Tractor. 6-7



Basic Automation Solution

Power Wave® AC/DC 1000® SD
MAXsa® 10 Controller 8-9
MAXsa® 22 Feed Head 10-11



Integrated and Robotic Solutions

Power Wave® AC/DC 1000® SD
MAXsa® 19 Controller
and MAXsa® 29 Feed Head. 12-14
Modified Series Arc™ 15
Robotic Submerged Arc Solutions 16

Appendix 17-27

Power Wave® AC/DC 1000® SD

Increase Productivity, Quality and Flexibility

The Power Wave® AC/DC 1000® SD delivers Waveform Control Technology® to submerged arc welding. Choose constant current or constant voltage operation and set variable frequency and amplitude. Software-driven AC, DC positive or DC negative output allows the user to control the deposition rate and penetration. The result over conventional power sources is increased weld speeds, consistently higher quality welds and improved efficiencies in a single or multi-arc environment.

Processes

- DC+ Submerged Arc
- DC- Submerged Arc
- Balanced AC Submerged Arc
- Variable AC Submerged Arc



Output



Input



Key Features

- **380 - 575 VAC, 50/60Hz Voltage Input** – Offers the ability to be connected anywhere in the world.
- **Voltage Compensation and Reliable Input Voltage Connection** – Provides consistent operation over $\pm 10\%$ input voltage variation.
- **No Hardware Reconfiguration Required with Easy Polarity Switching** – Eliminates downtime.
- **Easy to Parallel Machines or Run Multiple Arcs.**
- **3-Phase Voltage Input** – Eliminates the imbalance associated with transformer-based AC welding machines.
- **95% Power Factor Correction** – Enables connection of multiple machines on the same plant infrastructure for lower installation costs.
- **Severe Duty** – Can be stored outdoors. IP23 Rated.
- **ArcLink®, Ethernet, and DeviceNet™ Communication** – Offers remote process monitoring, control and troubleshooting.
- **True Energy™** – Measures, calculates and displays instantaneous energy in the weld for critical heat input calculations.
- **CheckPoint™** – A cloud-based system to view or analyze your welding data. Track equipment usage, store weld data, configure fault limits and more.
- **iARC™ Digital Control** - 90 times faster than the previous generation, delivering a responsive arc.
- **Factory Burn-In Tested** – At maximum output for 2 hours to ensure quality and reliability.

Technical Specifications

Product Name	Product Number	Input Voltage	Rated Output Current/Voltage/Duty Cycle	Input Current @ Rated Output	Output Range	Dimensions H x W x D in. (mm)	Net Weight lbs. (kg)
Power Wave® AC/DC 1000® SD	K2803-1 ⁽¹⁾	380/400/460/500/ 575/3/50/60	1000A/44V/100%	82/79/69/62/55	100-1000A	49.2 x 19.2 x 46.2 (1250 x 488 x 1174)	800 (363)

⁽¹⁾ Filter is required to meet CE conducted emission requirements. The K2444-3 must be used with the K2803-1.

KEY CONTROLS

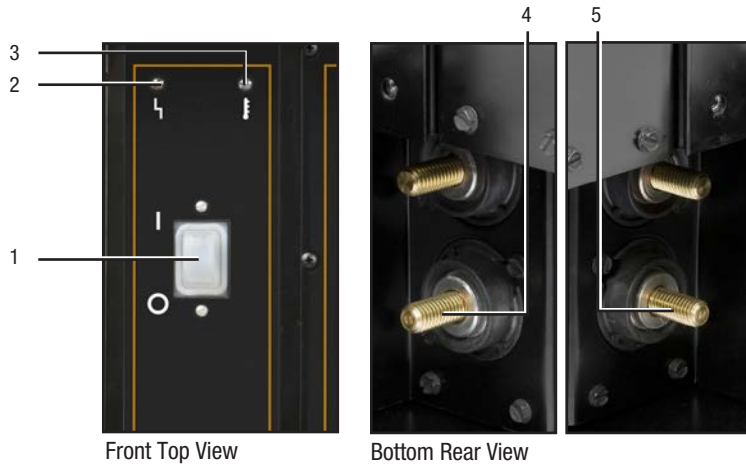

- | | |
|----------------------------------------------|---------------------------------------------|
| 1. Power Switch | 10. 10 Amp Wire Feeder Circuit Breaker |
| 2. Status Lights | 11. Auxiliary Output (115V, 10A AC) |
| 3. Thermal Light | 12. Input Cable Location |
| 4. Electrode Studs | 13. DeviceNET™ Connector |
| 5. Work Studs | 14. Controller ArcLink® Connector |
| 6. I/O Connectors for Synchronizing Machines | 15. I/O Connectors for Paralleling Machines |
| 7. Work Sense Lead Connector | |
| 8. Ethernet Connector | |
| 9. Auxiliary Power Circuit Breaker | |

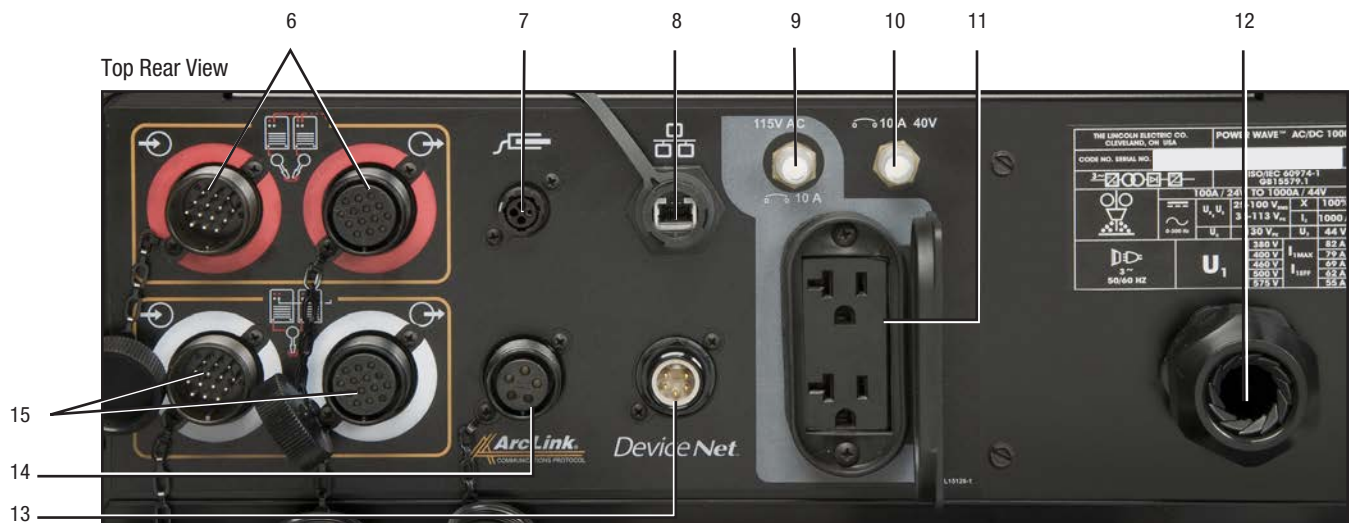

FEATURE LOADED, RUGGED CONSTRUCTION AND EASY MAINTENANCE

1. Easy Maintenance designed for Extreme Environments

- Pull-out back panel provides fast access to heat sinks and other components.
- Re-usable filter prevents particulate matter from entering the machine.

2. Easy-access Reconnect Panel

- Connect the Power Wave® AC/DC 1000® SD to an electrical connection almost anywhere in the world (380 up to 575 Volt input power).



Cruiser® and Tandem Cruiser® Tractors

For Extended Decking Welds

The self propelled, modular Cruiser® and Tandem Cruiser® travel carriages, used with the Power Wave® AC/DC 1000® SD power source, can deliver deposition rates up to 30 lbs per arc, per hour for butt and fillet joints on lengthy plate welding applications common in bridge or barge decking, large tank fabrication or shipbuilding.

Processes
Submerged Arc

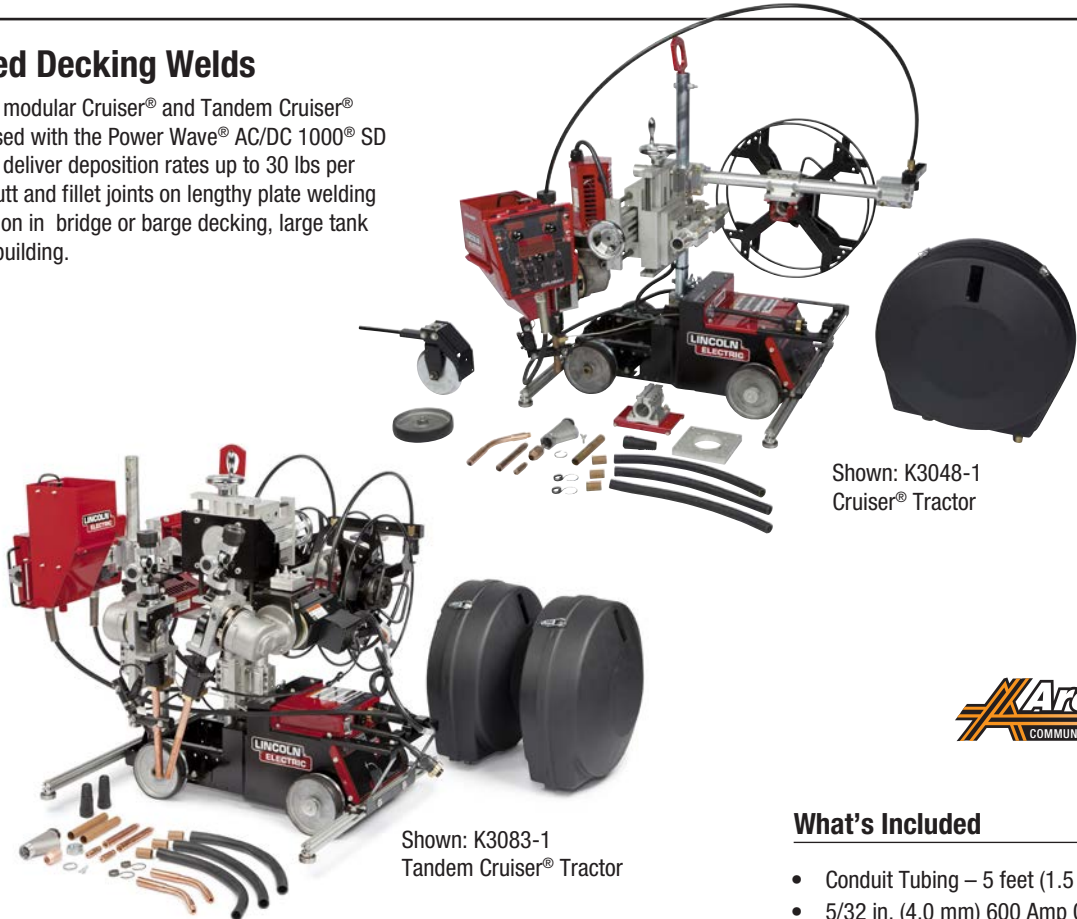

Output



Input



Shown: K3048-1
Cruiser® Tractor

Shown: K3083-1
Tandem Cruiser® Tractor



Key Features

- **Reliable Operation** – Strong, rigid and stiff especially where you need it most.
- **Advanced Control Pendant** – Removable, lightweight, impact resistant aluminum user interface can be used to save procedures, apply limits and lockouts for any or all controls.
- **Common Expendable Parts** – All drive rolls, nozzles, contact tips and wire straighteners are shared with the MAXsa® submerged arc wire drives.
- **Multiple Configurations** – Flexible system allows set up with or without a track and three or four wheel operation. Tandem model not recommended for three wheel operation.

What's Included

- Conduit Tubing – 5 feet (1.5 m)
 - 5/32 in. (4.0 mm) 600 Amp Contact Nozzle Assembly
 - 5/32 in. (4.0 mm) Contact Tip
 - Nozzle Extension – 5 in. (127 mm)
 - Curved Nozzle Extension, 45°
 - Nozzle Extension Insulator
 - Flux Tubing
 - Flux Hose Clamps
 - Wire Reel Assembly
 - Wheels for Track Operation
 - Cross Slide Assembly (2 for Tandem)
 - Front and Rear Outriggers
 - Enclosed Wire Reel (2 for Tandem)
 - K1733-5 Wire Straightener (2 for Tandem)
- Note: Control cable not included

Technical Specifications

Product Name	Product Number	Input Power	Rated Output Current/Duty Cycle	Travel Speed in/min (m/min)	Gearing	Wire Feed Speed Range ipm (m/min)	Wire Size Range in. (mm) Solid	Dimensions H x W x D in. (mm)	Net Weight lbs. (kg)
Cruiser® Tractor	K3048-1	40 VDC	1000A / 100%	10 - 100 (0.25 - 2.5)	142:1	15 - 200 (0.4 - 5.0)	3/32 - 7/32 (2.4 - 5.6)	29 x 23 x 36 (736 x 584 x 914)	207 (94)
					95:1	15 - 300 (0.4 - 7.6)	1/16 - 1/8 (1.6 - 3.2)		
Tandem Cruiser® Tractor	K3083-1				57:1	50 - 500 (1.3 - 12.7)	1/16 - 3/32 (1.6 - 2.4)	36.5 x 45.5 x 41.5 (927 x 1156 x 1054)	300 (136)

KEY CONTROLS
CRUISER®

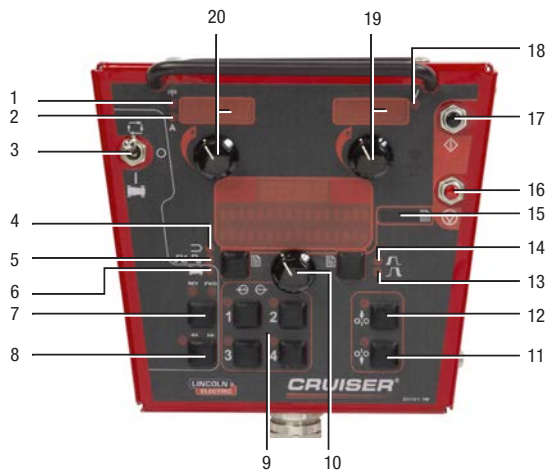

TANDEM CRUISER®

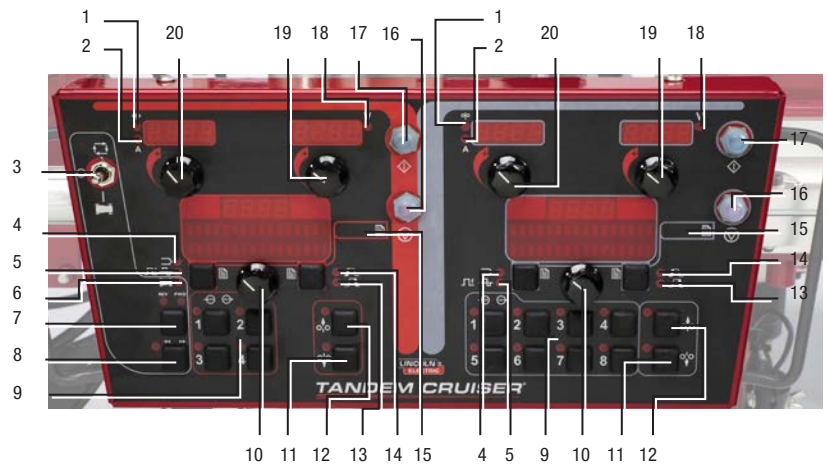

- | | | | |
|----------------------------------------|-------------------------------------|--------------------------------------|----------------------------------|
| 1. WFS LED | 6. Travel Menu (Left Button) | 13. Arc End Options (Right Button) | 19. Voltage Display and Control |
| 2. AMPS LED | 7. Travel Direction | 14. Arc Start Options (Right Button) | 20. WFS/Amps Display and Control |
| 3. Auto / OFF / Manual Travel Switch | 8. Jog | | |
| 4. Weld Mode Selection (Left Button) | 9. Memories | | |
| 5. Frequency and Balance (Left Button) | 10. Mode Select Display and Control | | |
| | 11. Inch Down | | |
| | 12. Inch Up | | |

RUGGED DESIGN & FLEXIBLE ADJUSTMENT FOR ANY CONFIGURATION

1. Improved Rigidity and Stiffness
2. Heavy Duty Cross Slides
3. New Rugged Wheels
4. Modified Mast and Boom Clamping System
5. Proven Industrial Wire Drive
6. Cable Rack
7. Laser Pointer and Improved Steering
8. Tandem Cruiser® for greater weld deposition

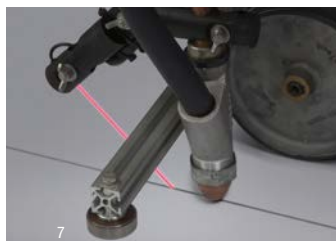

MAXsa[®] 10 Controller

ArcLink[®]-enabled Controller for Power Wave[®] AC/DC 1000[®] SD Systems

The MAXsa[®] 10 controller offers a single monitoring and control point for the entire hard automation welding system. Operators have full control over AC and DC welding parameters and easy PLC interfacing to control fixture travel, timers and other system commands.

Processes
Submerged Arc



Output

40
VDC

Input

40
VDC



Key Features

- **Severe Duty Ready** – The controller is IP23 rated and ready for operation in harsh environments.
- **Pendant Box** – Mount the controller in the standard protective box or remove the pendant for hand-held operation. Extend hand-held operation from 4 feet (1.2 m) up to 100 feet (30.5 m) with an ArcLink[®] extension cable.
- **Eight Procedure Memories** – Pre-set and save your optimal welding parameters for repeating applications and recall later for fast changeovers.
- **User-Friendly Controls** – Clear digital display and controls make it easy to set weld modes, AC operation, strike/start/end options, travel stop/start, timers and other parameters.
- **Limit Control** – Apply operator procedure limits or lockout on any or all parameters.
- **Waveform Control Technology[®]** – Allows the user to choose from a library of pre-programmed weld modes. Parameters for each mode can be adjusted within a limited range to achieve optimal balance between deposition rate and penetration.

Technical Specifications

Product Name	Product Number	Input Power	Dimensions H x W x D in. (mm)	Net Weight lbs. (kg)
MAXsa [®] 10 Controller	K2814-3	40 VDC	15 x 13 x 4 (381 x 259 x 102)	25 (11.3)

KEY CONTROLS

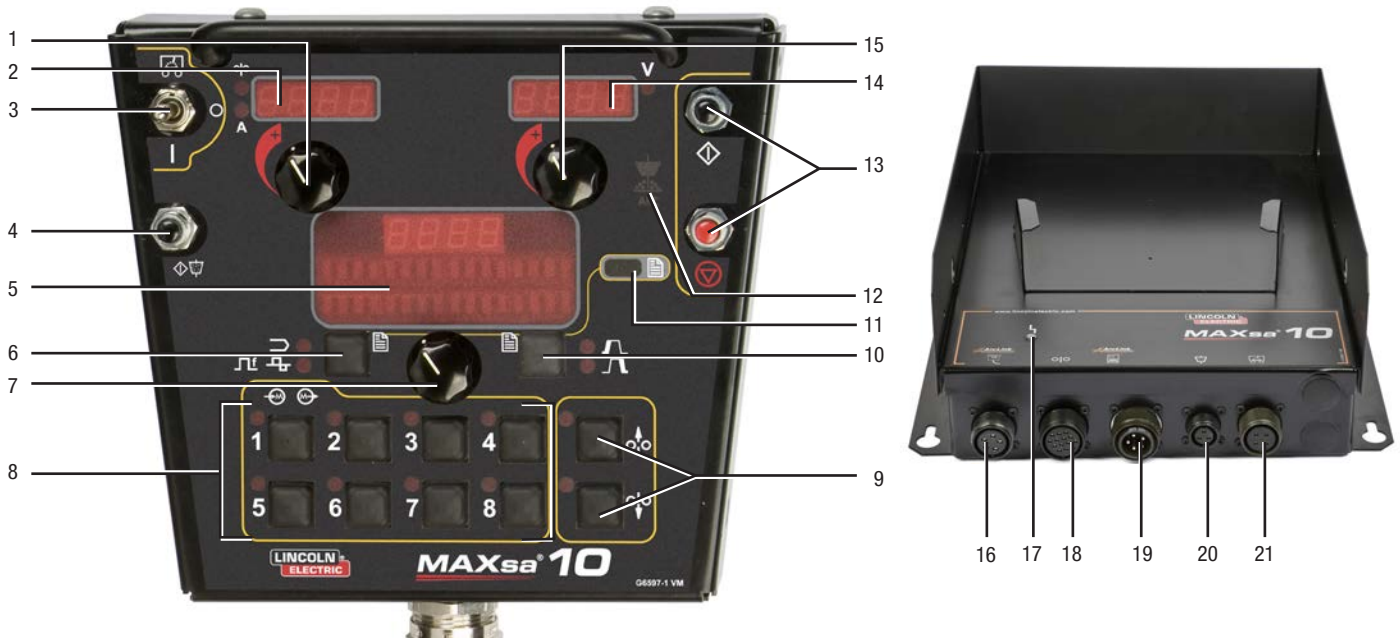

- 1. AMPS/WFS Control**
- 2. AMPS/WFS Display**
 - AMPS Indicator Light
 - WFS Indicator Light
- 3. Travel Switch**
 - Auto/Off/Manual
- 4. Flux Hopper Switch**
- 5. Mode Select Panel (MSP) Display**

- 6. Weld Mode Selector**
 - Weld Mode Indicator Light
 - Frequency/Balance Indicator Light
- 7. Mode Select Panel Control Knob**
- 8. Eight Memory Buttons:**
 - Save common procedures
 - Apply operator range or limits
 - Lockout changes for procedure control

- 9. Feed Reverse/Feed Forward Buttons**
- 10. Arc Start/End Options Selector**
 - Start Options Indicator Light
 - End Options Indicator Light
- 11. Set-Up Menu Indicator**
- 12. Arc Established Indicator**
- 13. Stop/Start Buttons**
- 14. Volts Display**
 - Volts Indicator Light

- 15. Volts Control**
- 16. User Interface/Pendant Connector**
- 17. Status LED**
- 18. Wire Drive Connector**
- 19. Power Source Connector**
- 20. Flux Hopper Connector**
- 21. Travel Carriage Connector**

RUGGED DESIGN, FLEXIBLE CONNECTION

- 1. IP23 Rated** – Tested and approved to withstand rain, humidity, dust and other environmental conditions. When placed vertically, the unit can be stored outdoors.
- 2. Hard Automation Connection** – Motion control, limit switches, PLC inputs and other auxiliary equipment are easily added to control device starting, stopping and other functions.
- 3. Hand-held Options** – The protective base unit shell facilitates fixed mounting and protects the controller. To get closer to the work, detach the controller for hand-held operation.



MAXsa[®] 22 Feed Head

Submerged Arc Hard Automation Feed Head

Designed specifically for hard automation applications, the MAXsa[®] 22 Feed Head delivers accurate wire feeding of large diameter submerged arc wires. Based on Lincoln's proven gearbox and cast aluminum feedplate, the MAXsa[®] 22 model features a 40VDC permanent magnet, high torque motor that delivers plenty of traction to push up to 7/32 in. (5.6 mm) diameter solid wire. A top speed of up to 500 ipm (12.7 m/min) can be achieved by changing the gear ratio.



Output



Input



Processes
Submerged Arc



Key Features

- **Flexible Configuration** – Can be used in single, tandem, Twinarc[®] or multiple arc applications.
- **Closed Loop Speed Control** – Facilitates full control over starting, running and stopping wire feed speed.
- **IP23 Rated** – Tested to withstand harsh environments.
- **Additional Gear Sets included** – Used to change the speed ratio to match the requirements of your application.
- **Multi-Axis Rotation** – Rotational feed head adjustment in two planes allows flexible, accurate setup for fixturing or arc locating. Additional positioning flexibility can be achieved with optional horizontal and vertical lift adjusters.
- **Standard Accessories** – Including an adjustable wire straightener, cross-seam adjuster and electrical valve flux hopper and mounting bracket for TC-3 carriage.

Technical Specifications

Product Name	Product Number	Input Power	Rated Output Current / Duty Cycle	Gear Box	Wire Feed Speed Range ⁽¹⁾ ipm (m/min)	Wire Size Range ⁽¹⁾ in. (mm) Solid	Dimensions H x W x D in. (mm)	Net Weight lbs. (kg)
MAXsa [®] 22 Feed Head (includes flux hopper)	K2370-2	40 VDC	1000A/100%	142:1 ⁽¹⁾	15 - 200 (0.4 - 5.0)	3/32 - 7/32 (2.4 - 5.6)	23.5 x 17 x 20 (597 x 432 x 508)	80 (36.3)
				95:1 ⁽¹⁾	15 - 300 (0.4 - 7.6)	1/16 - 1/8 (1.6 - 3.2)		
				57:1 ⁽¹⁾	50 - 500 (1.3 - 12.7)	1/16 - 3/32 (1.6 - 2.4)		

⁽¹⁾ 142:1 gear set is standard. Additional gears supplied for conversion to 95:1 and 57:1 with Wire Drive (K2370-2, K2312-2, or K2311-1).

KEY CONTROLS

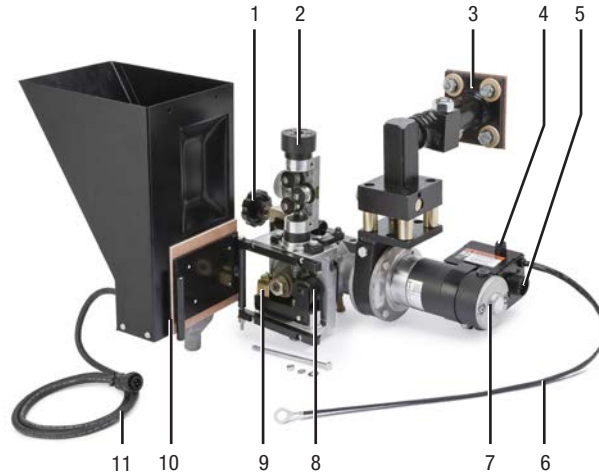

- 1. Cross Seam Adjuster
- 2. Wire Straightener
- 3. Mounting Bracket
- 4. Fuse
- 5. 14-Pin Connector
- 6. Lead (67)
- 7. Motor
- 8. Idle Roll Arm
- 9. Tension Indicator
- 10. Flux Hopper
- 11. Flux Valve Connector

OPTIONAL TC-3 TRAVEL CARRIAGE

TC-3 Travel Carriage

The TC-3 travel carriage allows the mounting of up to two feed heads/controllers and wire reels to a beam for basic hard automation installations.



Beam Profile

Recommended for the TC-3 travel carriage. (See manual for more precise dimensions.)

- 8 in. (203 mm)
- 10 in. (254 mm)
- 12 in. (305 mm)

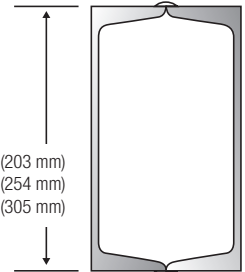

CONTACT NOZZLES (ONE REQUIRED)

- 1. **Submerged Arc Contact Nozzle Assembly (K231-1)**
For 5/64 thru 3/16 in. (2.0 thru 4.8 mm) electrode at currents generally below 600 amps. Outer flux cone gives full flux coverage with minimum consumption. (Rated for up to 650 amps.)
- 2. **Positive Contact Assembly (K148A + K148B)**
For single arc welding at high currents.
- 3. **Contact Jaw Assembly (K226R)**
Single arc contact jaw assembly for 1/8 - 7/32 in. (3.2 - 5.6 mm) diameter wire. Maximum life at currents over 600 amps.
- 4. **ESO (Extended Stick-Out) Extension (K149-5/32)**
Linc-Fill long stickout extension for K148A Single Arc Positive Contact Nozzle Assembly. Required for long stickout technique.
- 5. **Narrow Gap Deep Groove Nozzle (K386)**
For single arc 3/32 in. (2.4 mm) diameter wire welding on thick walled steel plate with nearly parallel-sided, narrow gap joint preparations.
- 6. **Large Wire Twinarc® Contact Assemblies (K225)**
Feeds two 5/64 in. (2.0 mm), 3/32 in. (2.4 mm) or 1/8 in. (3.2 mm) wires for submerged arc welding on "Fast-Fill" joints or hardfacing beads.
- 7. **Tiny Twinarc® Contact Assemblies (K129-XX)**
Feeds two electrodes for high speed submerged arc welds. Includes contact nozzle, wire guides, drive rolls and guides, and a second wire reel and mounting bracket.



MAXsa[®] 19 and MAXsa[®] 19 MSA Controller

Submerged Arc Controllers for Fabrication Integrators and Robotic Applications

The MAXsa[®] 19 or MAXsa[®] 19 MSA (Modified Series Arc) controllers are specifically designed to relay wire feed commands to the MAXsa[®] 29 when a customer-supplied user interface is used in place of the MAXsa[®] 10 controller. Typically, this occurs in third party fabrication integrator solutions that include integration hardware like turning rolls, panel lines, seamers and pipe mills fixturing.

Modified Series Arc is a single pass, one-sided process developed for plate joining, typically in gantry-mounted applications. New digital solutions based on the use of the Power Wave[®] AC/DC 1000[®] SD advanced submerged arc welding power source provide a number of advantages over conventional Modified Series Arc systems.

Processes
Submerged Arc

Key Features

MAXsa[®] 19 Controller

- Compact size is easy to position in custom integrator solutions.
- Fast digital communication with the Power Wave[®] AC/DC 1000[®] SD via Arclink[®] cable and to the wire drive via a 14 pin control cable.
- Standard I/O connector block for start/stop, forward/reverse feed and shutdown input interfacing with external accessories.
- Standard Status indicator aids diagnostic system troubleshooting.
- IP23 Rated – Tested to withstand harsh environments.

Modified Series Arc™ process with MAXsa[®] 19 MSA Controller

Compared to conventional MSA systems:

- Greater Control
 - Direct control of the series wire and ground current, resulting in added stability, improved and consistent back bead appearance and independent control of the heat input and deposition rate.

Technical Specifications

Product Name	Product Number	Input Power	Rated Output Current / Duty Cycle	Dimensions H x W x D in. (mm)	Net Weight lbs. (kg)
MAXsa [®] 19 Controller	K2626-4	40 VDC	1000A / 100%	9 x 10.5 x 3 (229 x 267 x 76)	7 (3.2)
MAXsa [®] 19 MSA Controller	K3172-1	40 VDC	1000A / 100%	9 x 10.5 x 3 (229 x 267 x 76)	7 (3.2)



MAXsa[®] 19
Controller

MAXsa[®] 19 MSA
Controller

- Weld plates up to 3/4 in. thick vs. 5/8 in. thick with conventional systems.
- Presettable welding parameters, all set through the PLC
- Eight user procedure memories
- Fast, reliable digital system communication
- Run the third wire on CC or CV
- Three phase operation, compared to single phase for conventional systems.
- Weld production and quality monitoring through CheckPoint™ and WeldScore™ software.
- Increased Productivity
 - Travel Speeds increase up to 28%, depending on plate thickness.
 - Weld faster on thinner plate with lower heat inputs and reduced distortion.
- IP23 Rated – Tested to withstand harsh environments.

KEY CONTROLS

MAXsa® 19 Controller



1. Mounting Holes
2. Power Source 5-Pin ArcLink® Input Connector
3. Status LED
4. Wire Feeder Connector
5. I/O Connector



Bottom View

MAXsa® 19 MSA Controller



1. Mounting Holes
2. Status LED
3. Power Source 5-Pin ArcLink® Input Connector
4. ArcLink® Output Connector
5. Wire Feeder Connector
6. Cold Feed up/down



Bottom View

MAXsa[®] 29 Feed Head

Submerged Arc Feed Head for Fabrication Integrators and Robotic Applications

The compact MAXsa[®] 29 Feed Head is intended for integrator solutions as well as the latest submerged arc robotic applications.

Contact Lincoln Electric Automation Division via email at automation@lincolnelectric.com for more information on robotic applications.

Processes
Submerged Arc



KEY CONTROLS

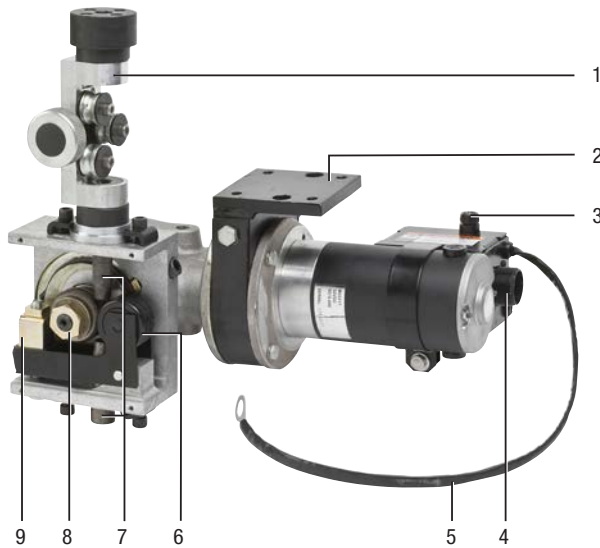

- 1. Wire Straightener
- 2. Mounting Bracket
- 3. Fuse
- 4. 14-Pin Connector
- 5. Lead (67)
- 6. Idle Roll Arm
- 7. Guide Tubes
- 8. Drive Rolls
- 9. Tension Indicator

Product Name	Product Number	Input Power	Rated Output Current / Duty Cycle	Gear Box	Wire Feed Speed Range ⁽¹⁾ ipm (m/min)	Wire Size Range ⁽¹⁾ in. (mm) Solid	Dimensions H x W x D in. (mm)	Net Weight lbs. (kg)
MAXsa [®] 29 Feed Head	K2312-2	40 VDC	1000A / 100%	142:1	15 - 200 (0.4 - 5.0)	3/32 - 7/32 (2.4 - 5.6)	13 x 16 x 10 (330 x 406 x 254)	35 (15.9)
				95:1	15 - 300 (0.4 - 7.6)	1/16 - 1/8 (1.6 - 3.2)		
				57:1	50 - 500 (1.3 - 12.7)	1/16 - 3/32 (1.6 - 2.4)		

⁽¹⁾ 142:1 gear set is standard. Additional gears supplied for conversion to 95:1 and 57:1 with Wire Drive (K2370-2, K2312-2, or K2311-1).

Modified Series Arc™ System

Greater Control. Increased Productivity

Modified Series Arc™ is a single pass, one-sided process developed for plate joining, typically in gantry-mounted applications. New digital solutions based on the use of the Power Wave® AC/DC 1000® SD advanced submerged arc welding power source provide a number of advantages over conventional Modified Series Arc™ systems.

Processes

- DC+ Submerged Arc
- DC- Submerged Arc
- Balanced AC Submerged Arc
- Variable AC Submerged Arc

Multiple Wire Applications

- Single Pass, One-Sided Plate Welding
- Gantry Mounted Systems

What's Included

Modified Series Arc One-Pak® (K3124-2)

- Power Wave® AC/DC 1000® SD (K2803-1) Qty 3
- MAXsa® 29 Feed Head (K2312-2) Qty 3
- MAXsa® 10 Controller (K2814-3) Qty 2
- MAXsa® 19 MSA Controller (K3172-1) Qty 1

Key Features

- Greater Control
 - Direct control of the series wire and ground current, resulting in added stability, improved and consistent back bead appearance and independent control of the heat input and deposition rate.
- Weld plates up to 3/4 in. (19 mm) thick.
- Increased Productivity
 - Travel speeds increase up to 28%, depending on plate thickness.
 - Weld faster on thinner plate with lower heat inputs and reduced distortion.



MAXsa® 19 MSA Controller



MAXsa® 29 Feed Head



MAXsa® 10 Controller



Power Wave® AC/DC 1000® SD

Product Name	Product Number	Input Power ⁽¹⁾	Rated Output Current / Duty Cycle	Gear Box	Wire Feed Speed Range ⁽²⁾ ipm (m/min)	Wire Size Range ⁽²⁾ in. (mm) Solid	Dimensions H x W x D in. (mm)	Net Weight lbs. (kg)
Modified Series Arc™ One-Pak®	K3124-2	Power Source: 380/400/460/500/575/3/50/60 Controllers & Feed Head: 40 VDC	1000A / 100%	142:1 ⁽¹⁾	15 - 200 (0.4 - 5.0)	3/32 - 7/32 (2.4 - 5.6)	NA	NA
				95:1 ⁽¹⁾	15 - 300 (0.4 - 7.6)	1/16 - 1/8 (1.6 - 3.2)		
				57:1 ⁽¹⁾	50 - 500 (1.3 - 12.7)	1/16 - 3/32 (1.6 - 2.4)		

⁽¹⁾ When not driving a motor. ⁽²⁾ 142:1 gear box is standard. Conversion Kit supplied for conversion to 95:1 and 57:1 with Wire Drive (K2370-2, K2312-2, or K2311-1).

Robotic Submerged Arc Solutions

Faster Arc Time. Consistent Quality.

Building on the digital component platform of the Power Wave® AC/DC 1000® SD power source and MAXsa® controllers and feed heads, the team at Lincoln Electric Automation developed an advanced robotic submerged arc welding system to enhance productivity for many heavy industry applications.

With robotic automation, operations can be moved to the next level with robot features such as touch sensing, path follow and vision-based arc guidance along with automated flux recovery.

Processes

- DC+ Submerged Arc
- DC- Submerged Arc
- Balanced AC Submerged Arc
- Variable AC Submerged Arc

Applications

- Structural Steel
- Process and Power Generation
- Wind Tower Fabrication
- Heavy Equipment
- Offshore
- Pipe Fabrication



Key Features

Robotic Submerged Arc Solutions

- Higher deposition rates at faster travel speeds
- Increased productivity and arc-on time
- Patented flux delivery system
- Engineered cable management system
- Fast digital system component communication

Contact Lincoln Electric Automation Solutions at 888.935.3878 or automation@lincolnelectric.com

DIGITAL COMMUNICATIONS AND SEAMLESS INTEGRATION

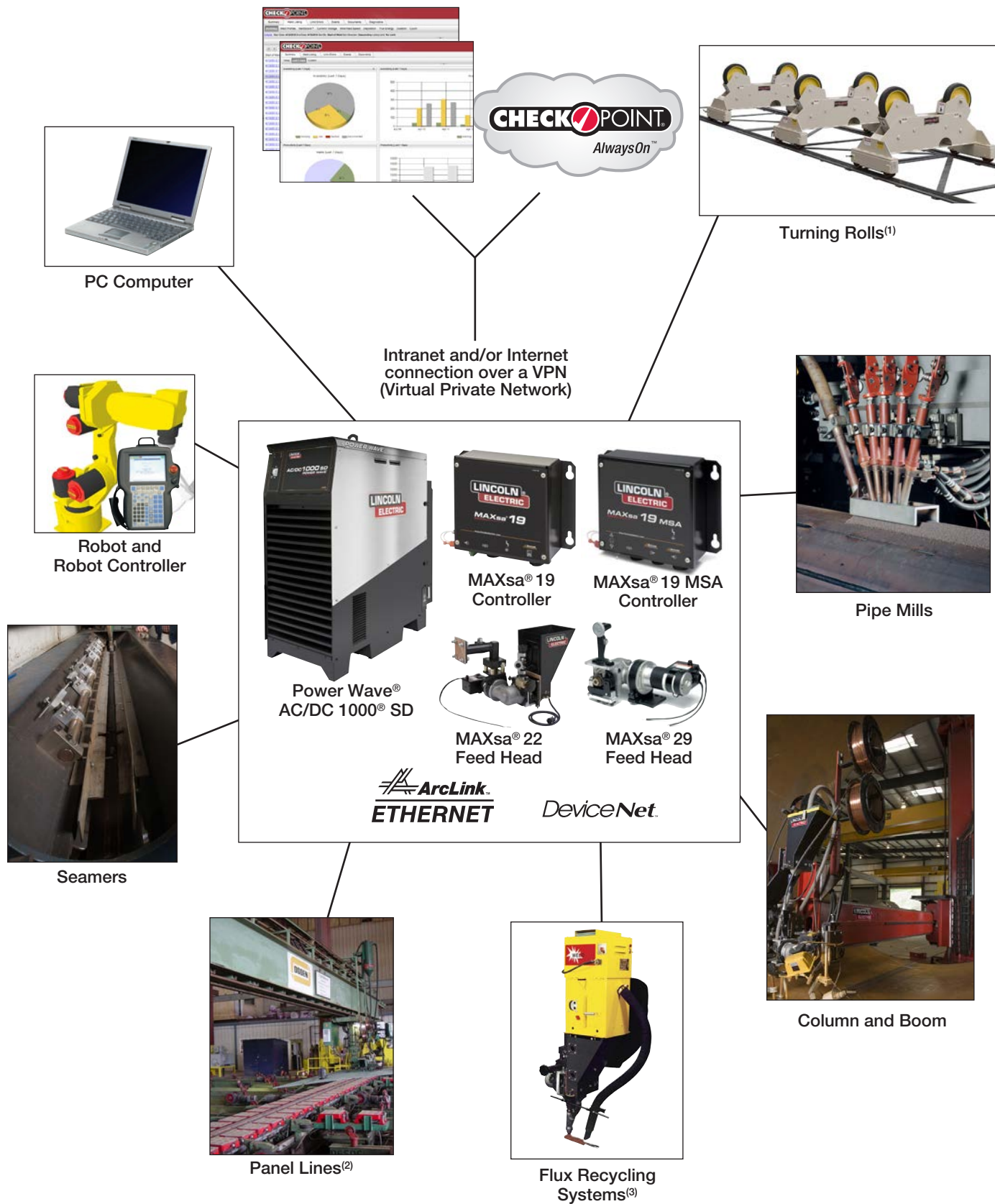

⁽¹⁾ Photo used with permission of Pandjiris, Inc. ⁽²⁾ Photo used with permission of Ogden Welding Systems, Inc. ⁽³⁾ Photo used with permission of Weld Engineering Co., Inc.

SINGLE ARC MOBILE CONFIGURATION

RECOMMENDED EQUIPMENT

Product Number	Product Description	Qty. Required
K2803-1	Power Wave® AC/DC 1000® SD	1
K3048-1	Cruiser® Tractor	1
K2683-xx	Heavy Duty ArcLink® Control Cable	1
K1811-xx	Work Sense Lead	1

Connection Diagram - Cruiser® Tractor System

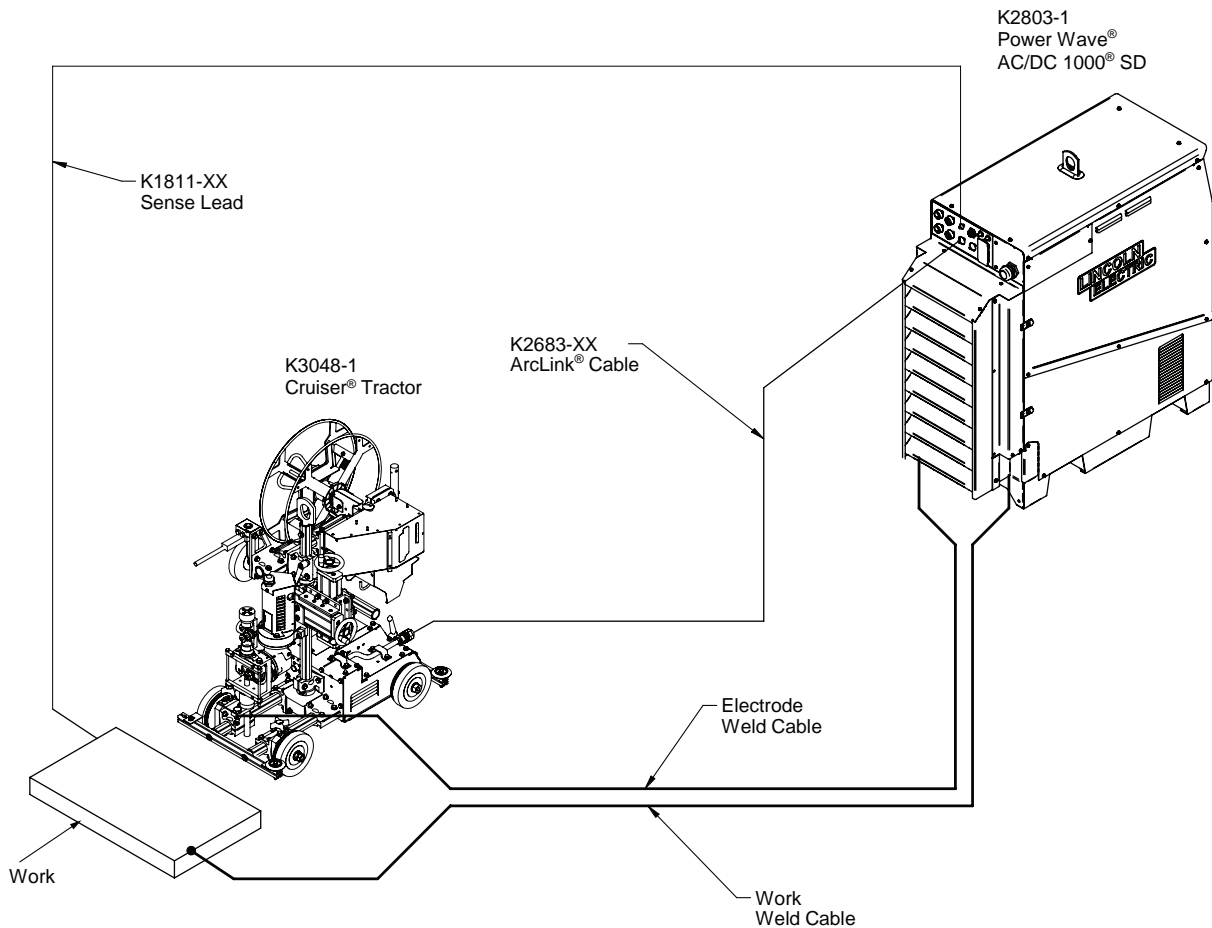

SINGLE ARC CONFIGURATION**RECOMMENDED EQUIPMENT**

Product Number	Product Description	Qty. Required
K2803-1	Power Wave® AC/DC 1000® SD	1
K2814-3	MAXsa® 10 Controller	1
K2370-2	MAXsa® 22 Feed Head	1
K231-1	Submerged Arc Contact Nozzle Assembly [3/32 in. (2.4 mm), 1/8 in. (3.2 mm), 5/32 in. (4.0 mm)]	1
K2683-XX	Heavy Duty ArcLink® Control Cable	1
K1785-XX	14-pin Control Cable	1
K1811-XX	Work Sense Lead	1

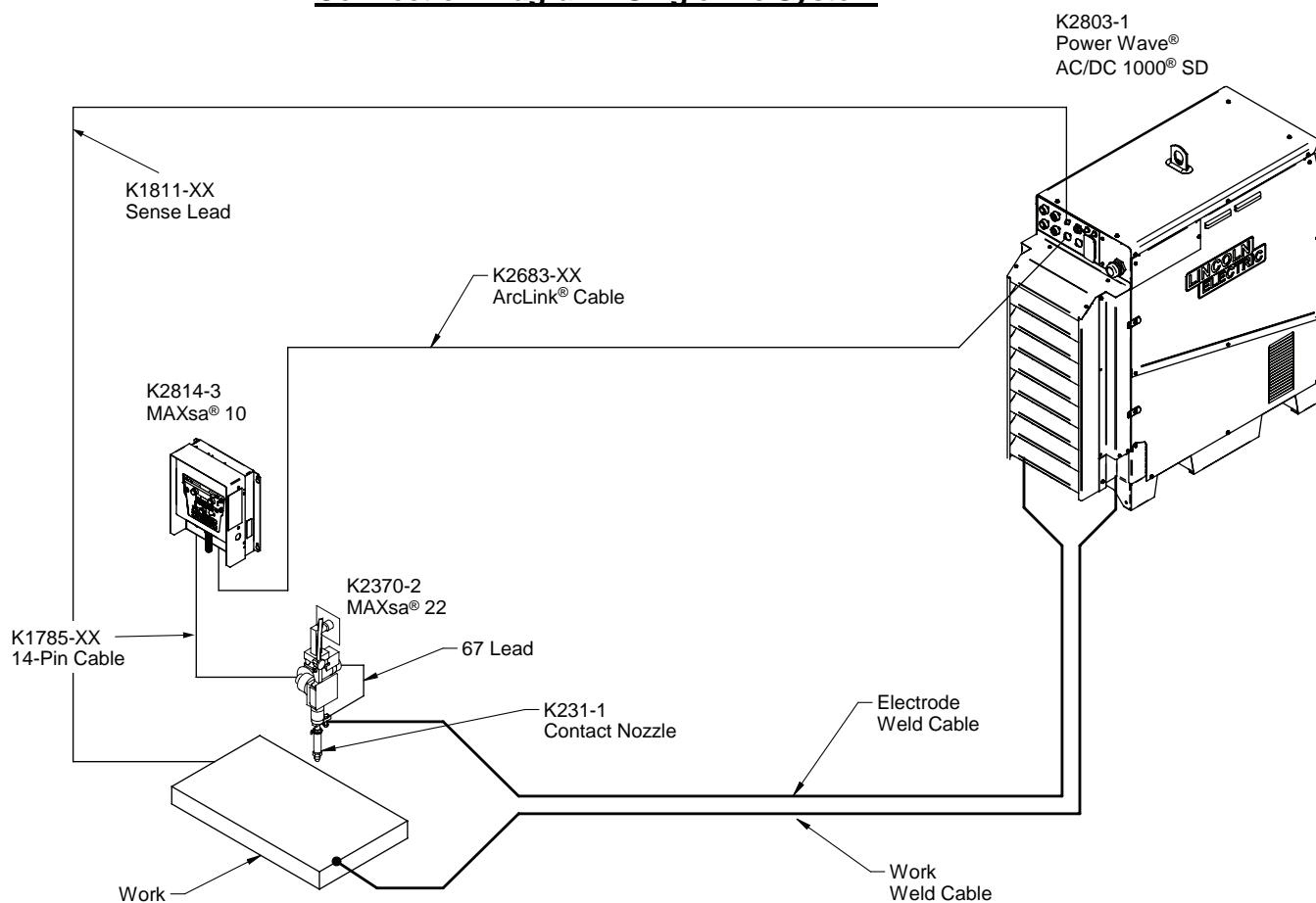
Connection Diagram - Single Arc System

DUAL ARC CONFIGURATION (For paralleling or more than two arcs, please contact your local Lincoln Electric Office.)

RECOMMENDED EQUIPMENT

Product Number	Product Description	Qty. Required
K2803-1	Power Wave® AC/DC 1000® SD	2
K2814-3	MAXsa® 10 Controller	2
K2370-2	MAXsa® 22 Feed Head	2
K231-1	Submerged Arc Contact Nozzle Assembly [3/32 in. (2.4 mm), 1/8 in. (3.2 mm), 5/32 in. (4.0 mm)]	2
K2683-XX	Heavy Duty ArcLink® Control Cable	2
K1785-XX	14-pin Control Cable (controller to wire drive)	2
K1785-XX	14-pin Control Cable (machine to machine)	1
K1811-XX	Work Sense Lead	1

Connection Diagram - Tandem Arc System

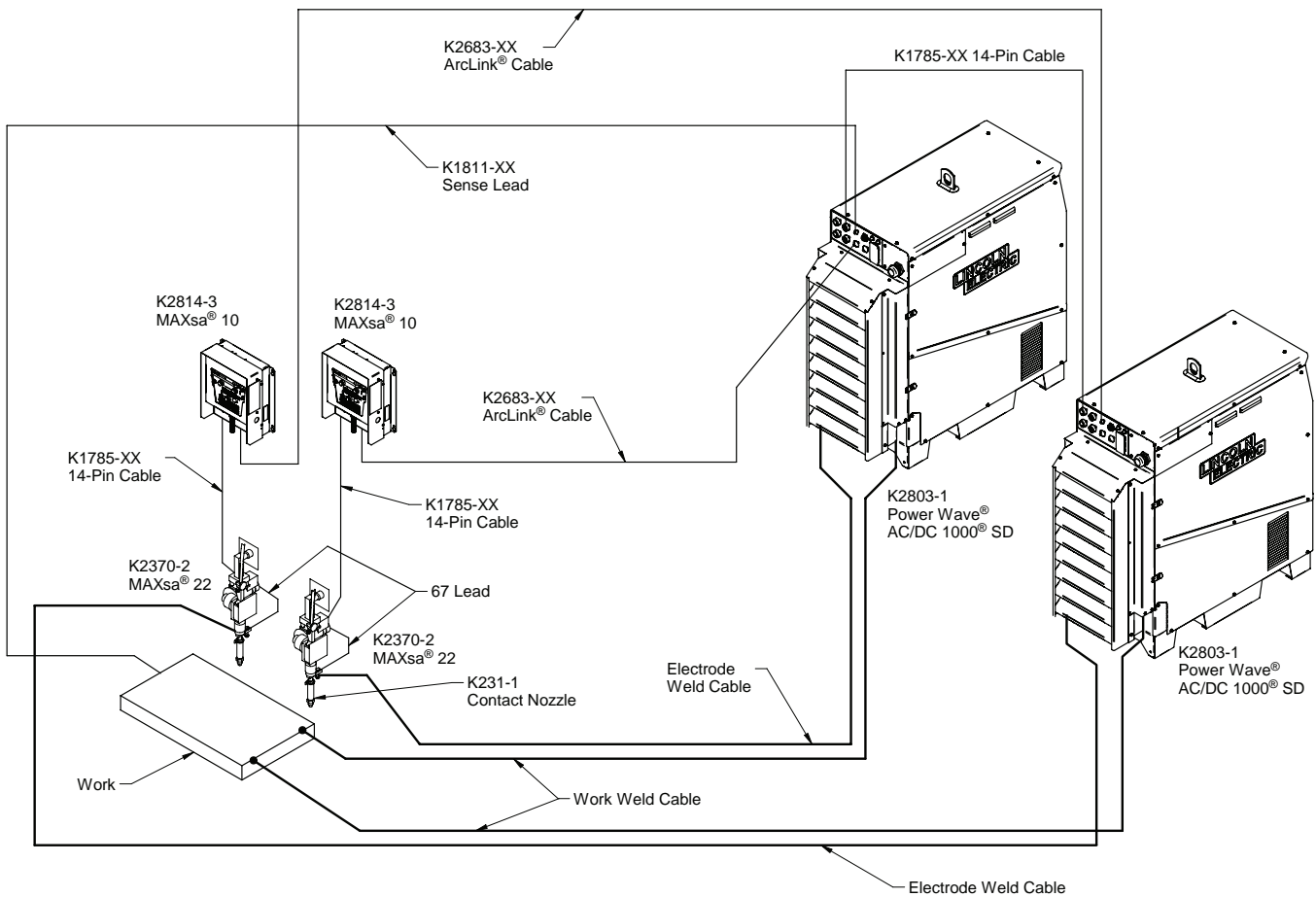

MODIFIED SERIES ARC™ CONFIGURATION

RECOMMENDED EQUIPMENT

Product Number	Product Description	Qty. Required
K2803-1	Power Wave® AC/DC 1000® SD	3
K2814-3	MAXsa® 10 Controller	2
K2312-2	MAXsa® 29 Feed Head	3
K3172-1	MAXsa® 19 MSA Controller	1
K148A	Positive Contact Nozzle Assembly 3/32 - 1/8	2
K148B	Positive Contact Nozzle Assembly 5/32 - 3/16	1
K2683-XX	Heavy Duty ArcLink® Control Cable	3
K1785-XX	14-pin Control Cable	5
K1811-XX	Work Sense Lead	2

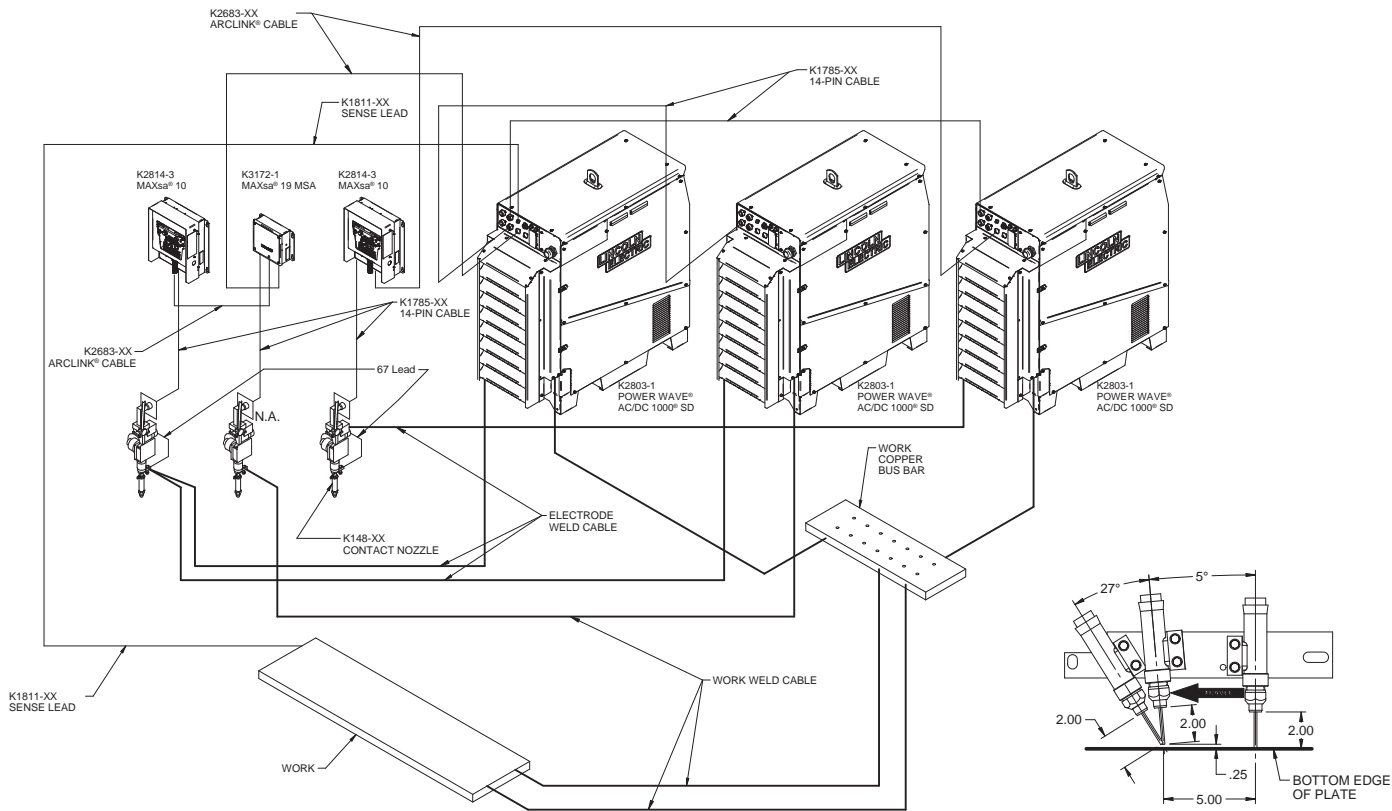

Mild Steel SAW Wire Feeding Capability

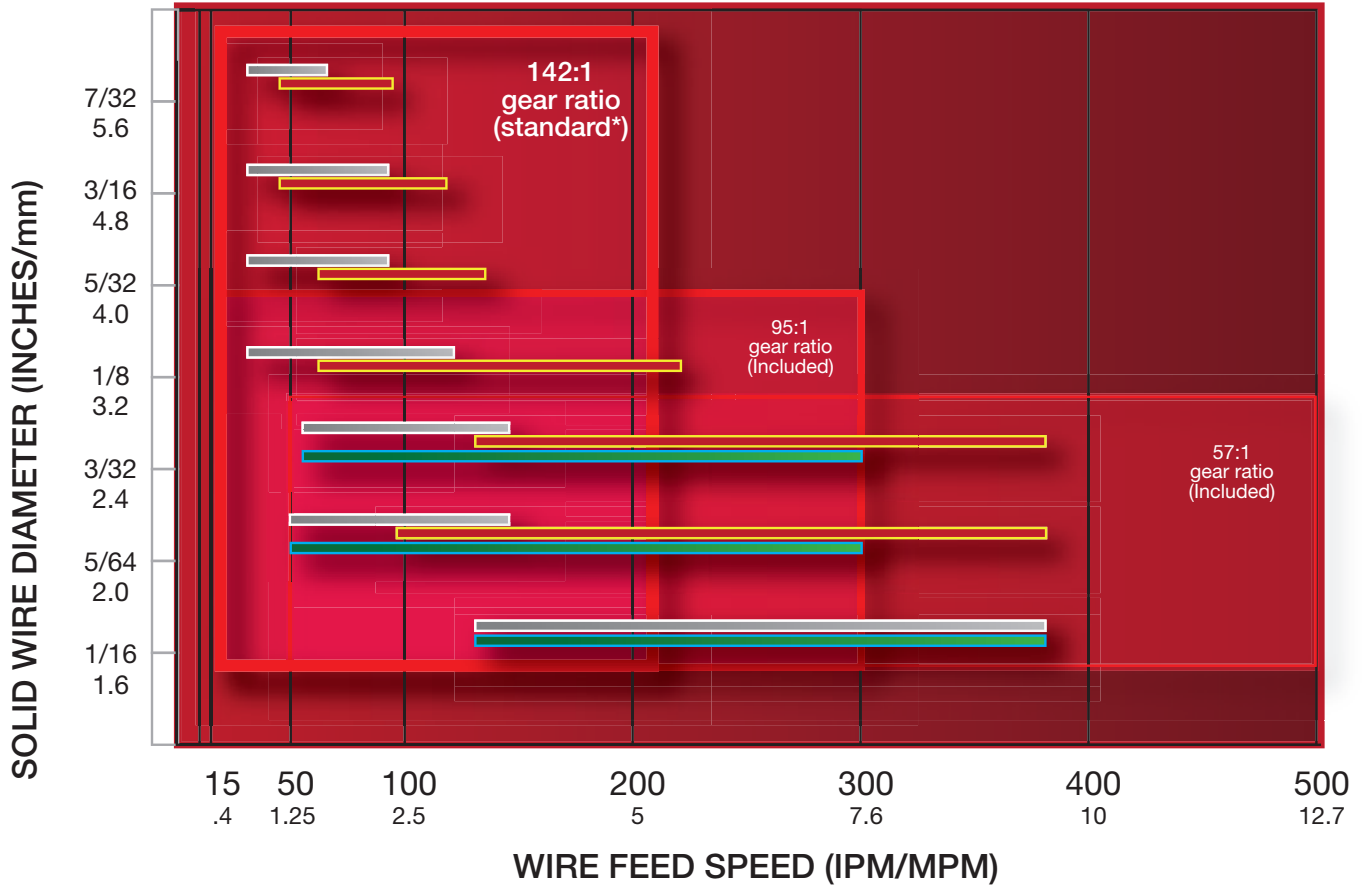

* On MAXsa® Feed Heads

14-PIN CONTROL CABLE (CANNOT BE EXTENDED)		
Length	Product No.	
4 ft. (1.2 m)	K1785-4	
12 ft. (3.7 m)	K1785-12	
16 ft. (4.9 m)	K1785-16	
25 ft. (7.6 m)	K1785-25	
50 ft. (15.2 m)	K1785-50	
100 ft. (30.5 m)	K1785-100	

5-PIN HEAVY DUTY ARCLINK® CONTROL CABLE [CAN BE EXTENDED UP TO 200 FT. (61 M) TOTAL LENGTH]			
	Length	Product No.	
Heavy Duty	25 ft. (7.6 m)	K2683-25	
	50 ft. (15.2 m)	K2683-50	
	100 ft. (30.5 m)	K2683-100	

SENSE LEAD KIT		
Length	Product No.	
50 ft. (15.2 m)	K1811-50	
100 ft. (30.5 m)	K1811-100	

WELD POWER CABLES		Product No.
For Up to 250 ft. (75 m) @ 80% Duty Cycle		
35 ft. - 2x4/0		K2163-35
60 ft. - 2x4/0		K2163-60
For Up to 250 ft. (75 m) @ 100% Duty Cycle		
10 ft. - 1x3/0		K1842-10
35 ft. - 1x3/0		K1842-35
60 ft. - 1x3/0		K1842-60

MAXsa® DRIVE ROLL KIT INFORMATION			
Product No.	Wire Sizes and Types		
KP1899-1	3/32 - 7/32 in.	Solid Wire	
KP1899-2	1/16, 5/64, 3/32 in.	Solid Wire	
KP1899-3	.035, .045, .052 in.	Solid Wire	
KP1899-4	.045 - .052 in.	Cored Wire	

RECOMMENDED ACCESSORIES AND OPTIONS

**Power Wave®
AC/DC 1000® SD**



CE Filter

This high power filter that enables Power Wave® AC/DC 1000® CE “ready” machine to conform to the EMC standards of Europe and Australia.

Order K2444-3

**MAXsa® 22 and
MAXsa® 29 Heads**



**MAXsa® 10
Mounting Bracket**

Allows for mounting the MAXsa® 10 to the TC-3 Travel Carriage. Cannot be used with K299.

Order K2462-1

**TC-3 Self-Propelled
Travel Carriage**

The TC-3 travel carriage allows the mounting of up to two feed heads/controllers and wire reels to a beam for basic hard automation installations.

Order K325 HCS
(for 5-75 ipm)



**Large Wire Twinarc®
Contact Assemblies**

Feeds two 5/64 in. (2.0 mm), 3/32 in. (2.4 mm) or 1/8 in. (3.2 mm) wires for submerged arc welding on “Fast-Fill” joints or hardfacing beads.

Order K225



**Twinarc® Solid Wire
Straightener**

Straightens wire diameters .045 thru 3/32 in. (1.2 thru 2.4 mm). Particularly valuable on longer electrical stickout procedures.

Order K281



**Tiny Twinarc® Contact
Assemblies**

Feeds two electrodes for high speed submerged arc welds. Includes contact nozzle, wire guides, drive rolls and guides, and a second wire reel and mounting bracket.

Order K129-xx



**Automatic Flux Hopper
Assembly**

Flux Hopper for MAXsa® 29 Heads (included standard on the MAXsa® 22 Heads)

Order K219

**MAXsa® 22 and
MAXsa® 29 Heads and
TC-3 Tractor**

Tandem Reels

Two Wire Reel Mounting for TC-3.

Order K390



Tandem Arc Framework

Provides mountings with desired positioning adjustments for two standard Automatic Wire Feed Heads. Includes insulation and hardware to permit direct mounting to a high capacity TC-3 Carriage, or to the user’s gantry or fixture for either direction of travel.

Order K387



**Flux Hopper for
Tandem Arc**

Flux Hopper for K387 mountings.

Order K389



Vertical Lift Adjuster

Provides 4 in. (102 mm) hand crank adjustment of vertical head position. It also includes up to 3-3/4 in. (95.2 mm) in-and-out horizontal adjustment with stops that can be preset for simple repetition of the same adjustment.

Order K29



Horizontal Adjuster

Provides crank adjustment of head position. Has 2 in. (51 mm) horizontal travel.

Order K96



**Wire Reel Assembly for
50-60 lb. Coils**

Accommodates 50 lb. (22.7 kg) or 60 lb. (27.2 kg) coils of wire on automatic wire feeders. The unit includes a wire reel mounting spindle and braking system. Cannot be used with K2462-1.

Order K299



SpreadArc Oscillator

Oscillates head across the line of travel. Calibrated dwell time and oscillation speed controls permit the SpreadArc to cover large areas quickly with smooth beads of minimum admixture.

Order K278-1

**MAXsa® 22 and
MAXsa® 29 Heads,
Cruiser® and Tandem
Cruiser® Tractors**

**Wire Straightener (Subarc)
up to 7/32 in. (5.6 mm)**

Includes a three roll wire straightener with adjustable pressure.

Order K1733-5



**Submerged Arc Contact
Nozzle Assembly for 3/32 in.**

**(2.4 mm), 1/8 in. (3.2 mm) and
5/32 in. (4.0 mm) electrodes.**

For 5/64 in. (2.0 mm), 3/16 in. (4.8 mm) or 7/32 in. (5.6 mm) sizes, order additional appropriate KP1962 tips. Outer flux cone gives full flux coverage with minimum consumption.

(Rated up to 650 amps.)

Order K231-1



RECOMMENDED ACCESSORIES AND OPTIONS - CONT.



**K231 Nozzle Contact Tips
Severe Duty
Order**

- KP2082-2B1**
for 5/64 in. (2.0 mm) wire
- KP1962-3B1**
for 3/32 in. (2.4 mm) wire
- KP1962-1B1**
for 1/8 in. (3.2 mm) wire
- KP1962-4B1**
for 5/32 in. (4.0 mm) wire
- KP1962-2B1**
for 3/16 in. (4.8 mm) wire
- KP1962-5B1**
for 7/32 in. (5.6 mm) wire

**Extended Life
Order**

- KP3162-3B1**
for 3/32 in. (2.4 mm) wire
- KP3162-1B1**
for 1/8 in. (3.2 mm) wire
- KP3162-4B1**
for 5/32 in. (4.0 mm) wire
- KP3162-2B1**
for 3/16 in. (4.8 mm) wire
- KP3162-5B1**
for 7/32 in. (5.6 mm) wire

Positive Contact Assembly

For single arc welding at high currents (optional T12928 water cooling attachment recommended when welding over 600 amps).

- Order K148A**
(for 3/32 to 1/8 in. wire)
- Order K148B**
(for 5/32 to 3/16 in. wire)



**Concentric Flux
Cone Assembly**

For use with K148B, Positive Contact Nozzle Assembly. Gives concentric flux coverage around the electrode.

Order K285



Contact Jaw Assembly

Single arc contact jaw assembly for 1/8-7/32 in. (3.2-5.6 mm) diameter wire. Rugged contact jaws for maximum life at currents over 600 amps.

Order K226R



**ESO (Extended Stick-Out)
Extension**

Linc-Fill long stickout extension for K148A Single Arc Positive Contact Nozzle Assembly. Required for long stickout technique.

- Order K149-1/8**
- K149-3/32**
- K149-5/32**



**Narrow Gap Deep
Groove Nozzle**

For single arc 3/32 in. (2.4 mm) diameter wire welding on thick walled steel plate with nearly parallel-sided, narrow gap joint preparations.

Order K386



5 in. Nozzle Extension

Extends the wire for subarc nozzles by 5 inches [up to 1/4 in. (6.4 mm) diameter wire].

Order KP2721-1

**Cruiser® and Tandem
Cruiser® Tractors**

Tube and Clamp Kit

One 30 in. (762 mm) aluminum splined tube; two 15 in. (381 mm) aluminum splined tubes; one 30 in. (762 mm) steel tube; 8 clamp assemblies with keys; 2 outrigger assemblies; hardware.

Order K3090-1



Cross Slide Assembly

Includes two slides with 4 in. (102 mm) of travel.

Order K3089-1



Track Section

Each section provides 70 in. (1.8 m) of travel.

Order K396



50-60 lb. Coil Adapter

Adapts 50-60 lb. (22.7-27.2 kg) coils of Lincoln Electric electrode to 2 in. (51 mm) spindle.

Order K1504-1



Tiny Twin Kit for Cruiser®
Includes a second spindle, drive rolls and 95:1 gears.
Order K3070-1



**Butt Joint Guide Kit
(Tandem only)**
Used to track the joint and guide the Tandem Cruiser® for plate and decking applications.
Order K3154-1



Nozzle Extension, 45°
Frequently used when making horizontal fillet welds.
Order KP2721-2

WAVEFORM CONTROL TECHNOLOGY®

The waveform may be varied to:

- Control Penetration
- Control Bead Shape
- Minimize arc interactions which can cause arc blow

Waveform Control Technology® capability provides precise control over:

- AC Frequency
- Balance (Percentage of time in the positive polarity portion of one cycle)
- Offset (Positive/Negative Amplitude)

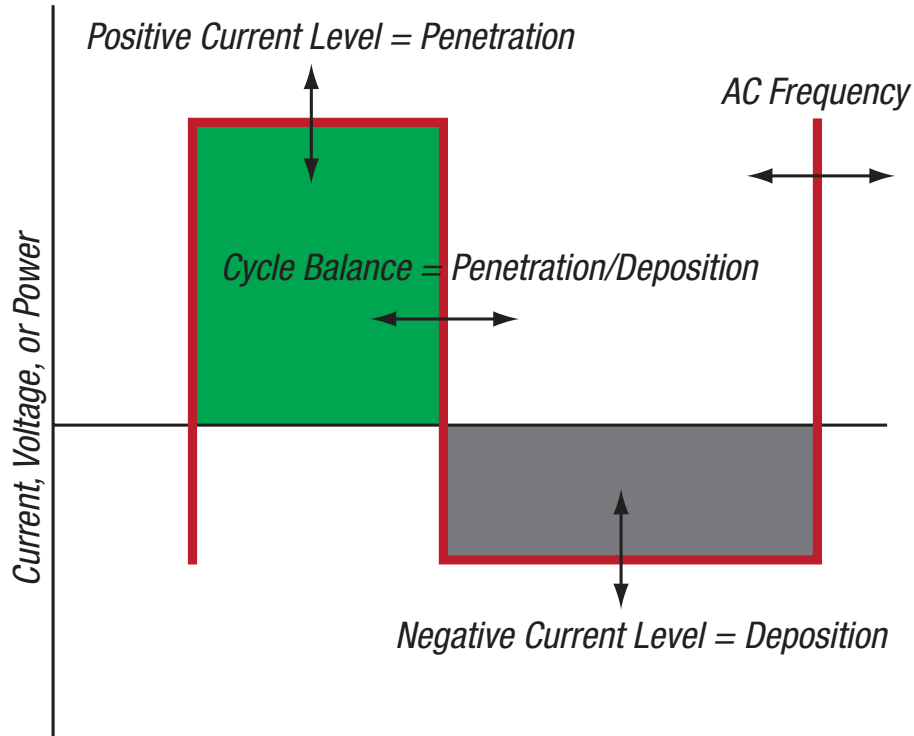

SOFTWARE DRIVEN CONTROL OVER PENETRATION, DEPOSITION RATE AND TRAVEL SPEED

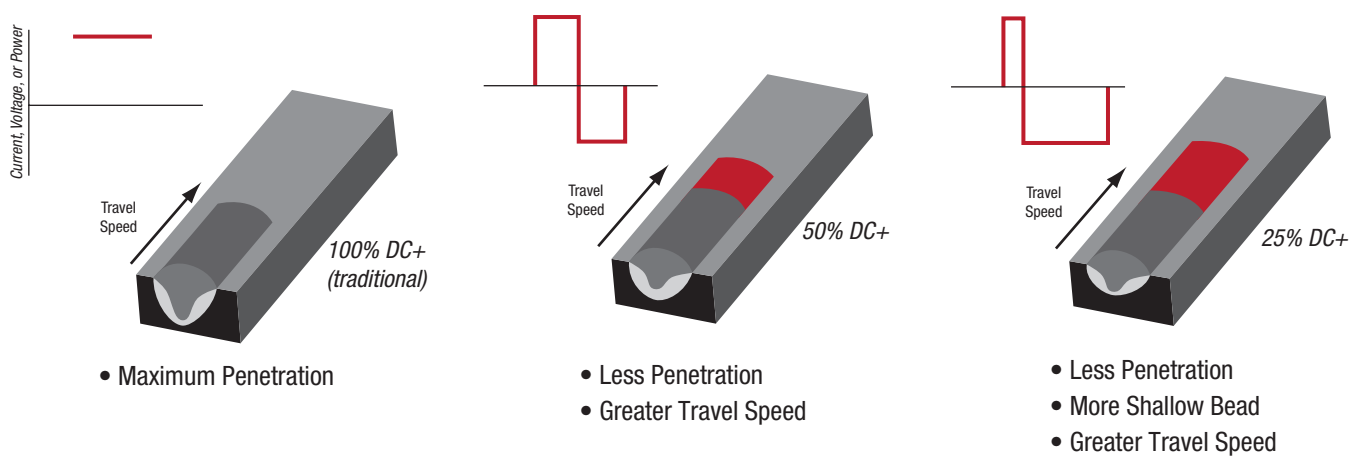

SINGLE ARC AND TWINARC® SUBMERGED ARC WELDING

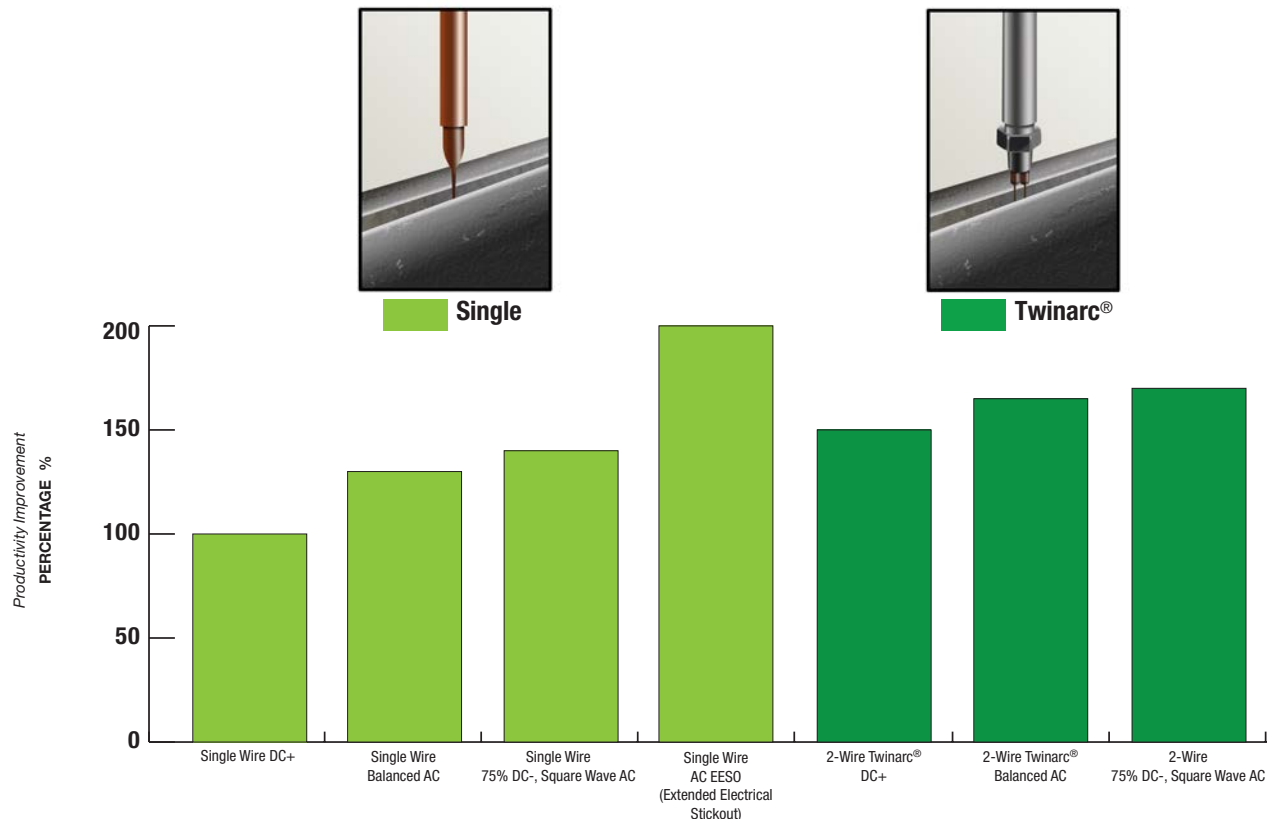

MULTI-ARC SUBMERGED ARC WELDING

Greater Productivity through Enhanced Control
- The Submerged Arc Advantage

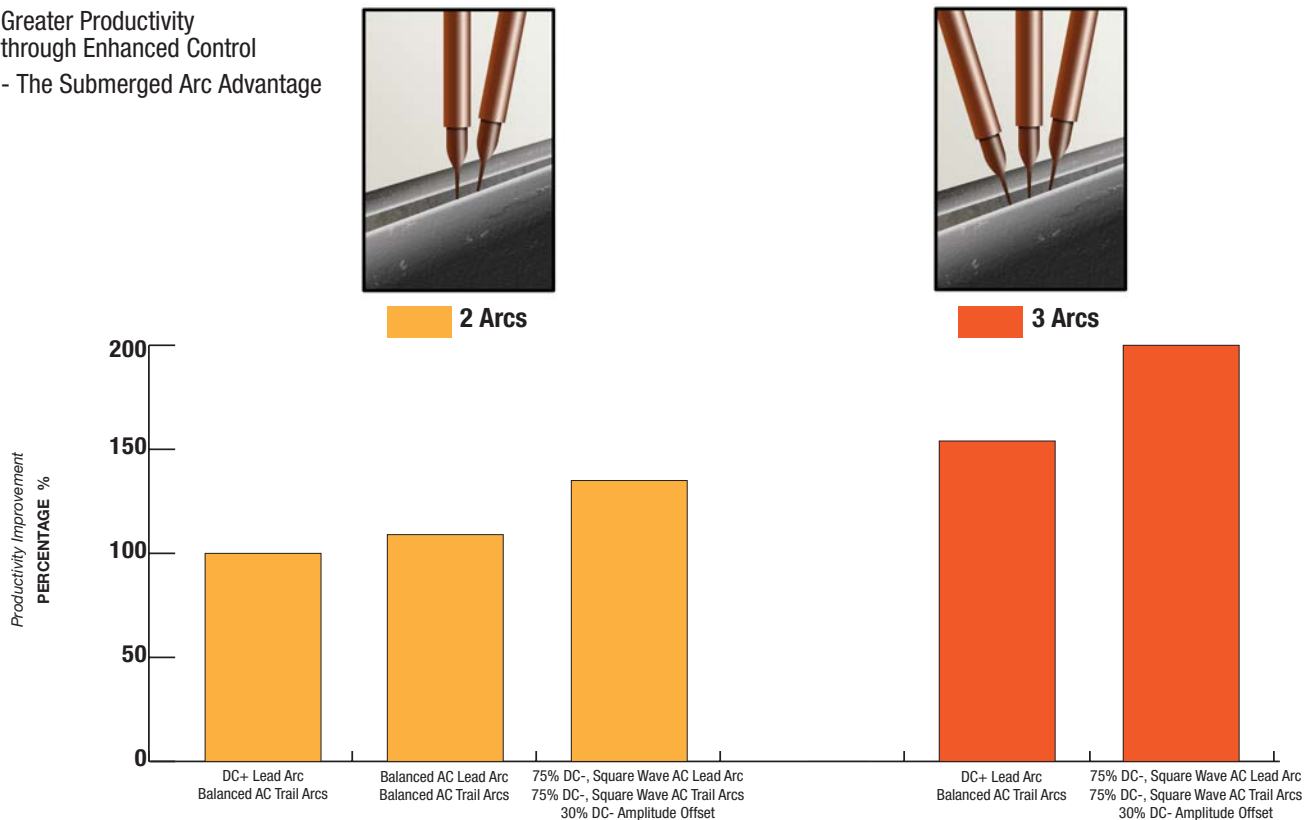

CUSTOMER ASSISTANCE POLICY

The business of The Lincoln Electric Company is manufacturing and selling high quality welding equipment, consumables, and cutting equipment. Our challenge is to meet the needs of our customers and to exceed their expectations. On occasion, purchasers may ask Lincoln Electric for information or advice about their use of our products. Our employees respond to inquiries to the best of their ability based on information provided to them by the customers and the knowledge they may have concerning the application. Our employees, however, are not in a position to verify the information provided or to evaluate the engineering requirements for the particular weldment. Accordingly, Lincoln Electric does not warrant or guarantee or assume any liability with respect to such information or advice. Moreover, the provision of such information or advice does not create, expand, or alter any warranty on our products. Any express or implied warranty that might arise from the information or advice, including any implied warranty of merchantability or any warranty of fitness for any customers' particular purpose is specifically disclaimed.

Lincoln Electric is a responsive manufacturer, but the selection and use of specific products sold by Lincoln Electric is solely within the control of, and remains the sole responsibility of the customer. Many variables beyond the control of Lincoln Electric affect the results obtained in applying these types of fabrication methods and service requirements.

Subject to Change – This information is accurate to the best of our knowledge at the time of printing. Please refer to www.lincolnelectric.com for any updated information.

Visit www.lincolnelectric.com



THE LINCOLN ELECTRIC COMPANY

22801 St. Clair Avenue • Cleveland, OH • 44117-1199 U.S.A.

Phone: +1.216.481.8100 • www.lincolnelectric.com